

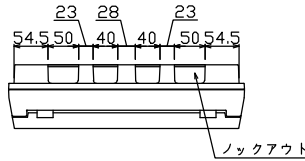

御納入先  
様

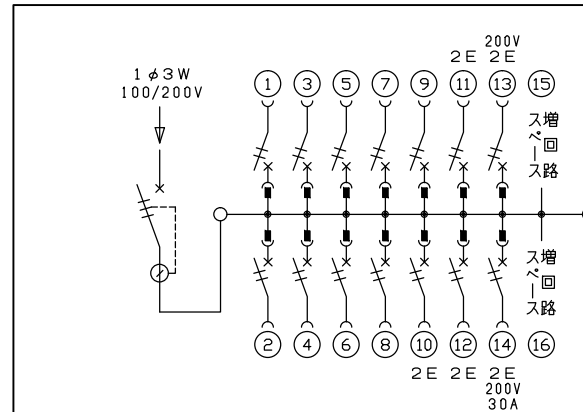

配線孔寸法図(斜線部開口)

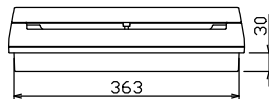
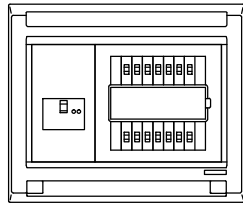
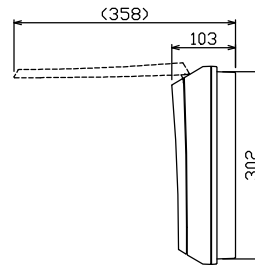
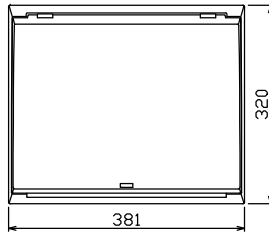
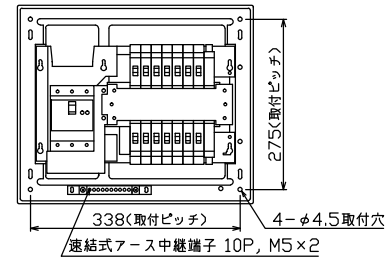

主幹) ELB 3P 50AF BC 5.0kA  
30mA高速形 単3中性線欠相保護付  
分岐) MCB 2P 30AF BC 2.5kA  
コード短絡保護機能付  
圧着端子: 14-6付属  
⑬回路: エコキュート用配線用遮断器  
⑭回路: IHクッキングヒーター用配線用遮断器

リミッター スペース (木板) (175×75)	主開閉器 漏電遮断器 3P2E 50A 6BU-53-1HEC	一次送り回路 P E A	分岐開閉器数 安全ブレーカ 2P1E 20A 2P2E 20A 2P2E 20A 2P2E 30A (200V) (IH用)				増回路 スペース 2	付属機器取付 スペース (木板) (175×75)	分電盤定格 定格電流 60A	キャビネット仕様 形式 露出・半埋込兼用形 材質 難燃性合成樹脂 (自己消火性) 色彩 マンセル 8GY9,7/0,2	日付 尺度 1/8 (A3基準) 承認 検図 設計 製図	名称 住宅用分電盤 MAG35132IA2 (エコキュート・IHクッキングヒーター用)	面 担当
-----------------------------------	---	-----------------	---	--	--	--	------------------	------------------------------------	----------------------	---	--	--	---------